

Craft centre this month was to create a city on the bulletin board. Each student could add 1 building, 1 house, 1 person and one animal or vehicle. We even changed the names of some buildings to reflect local businesses. I seem to remember shrinking the buildings down because I only had a small bulletin board space and 2 classes at work on the same city!

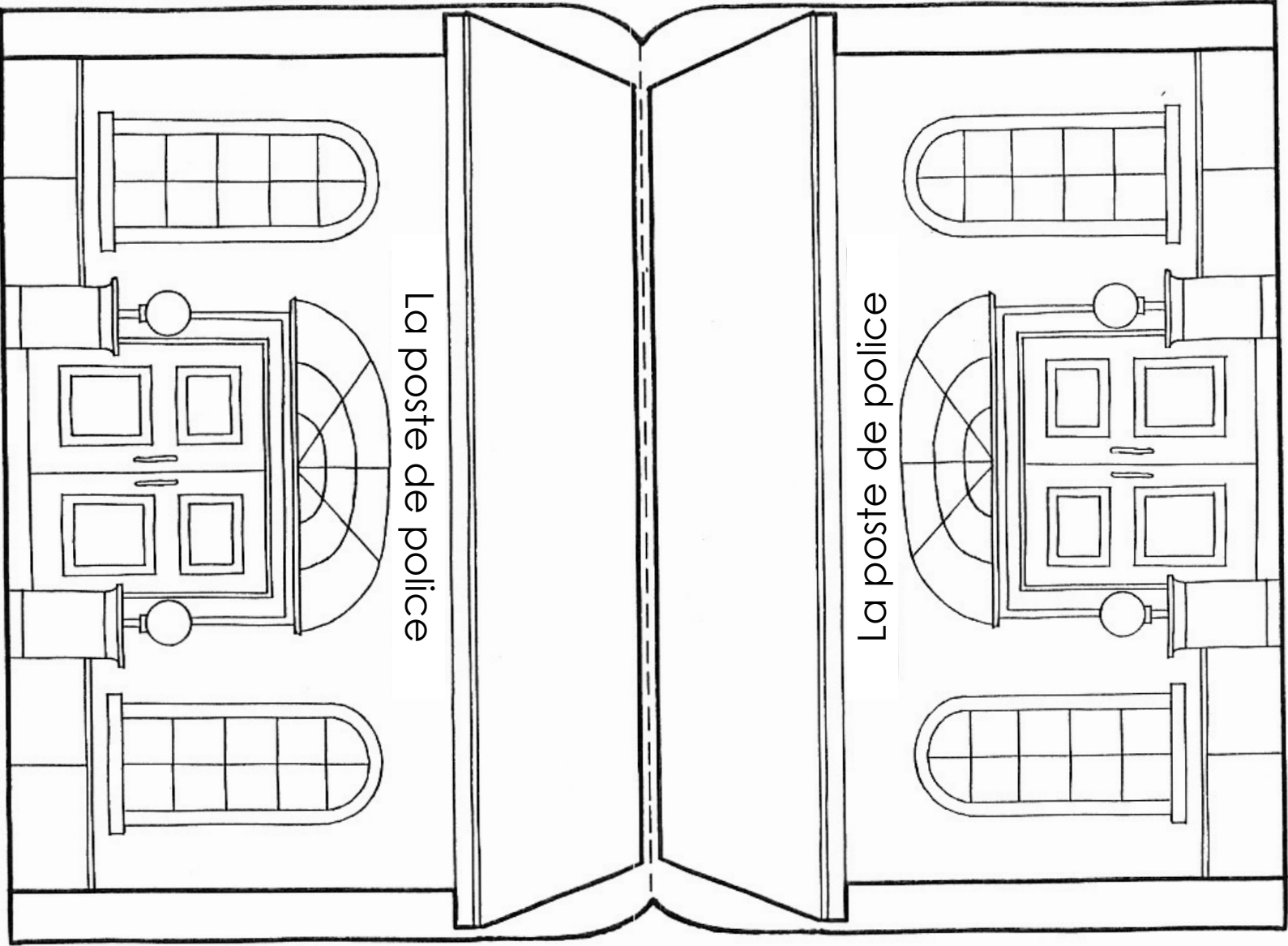



La poste de police

La poste de police

Dr. McDermid

La dentiste



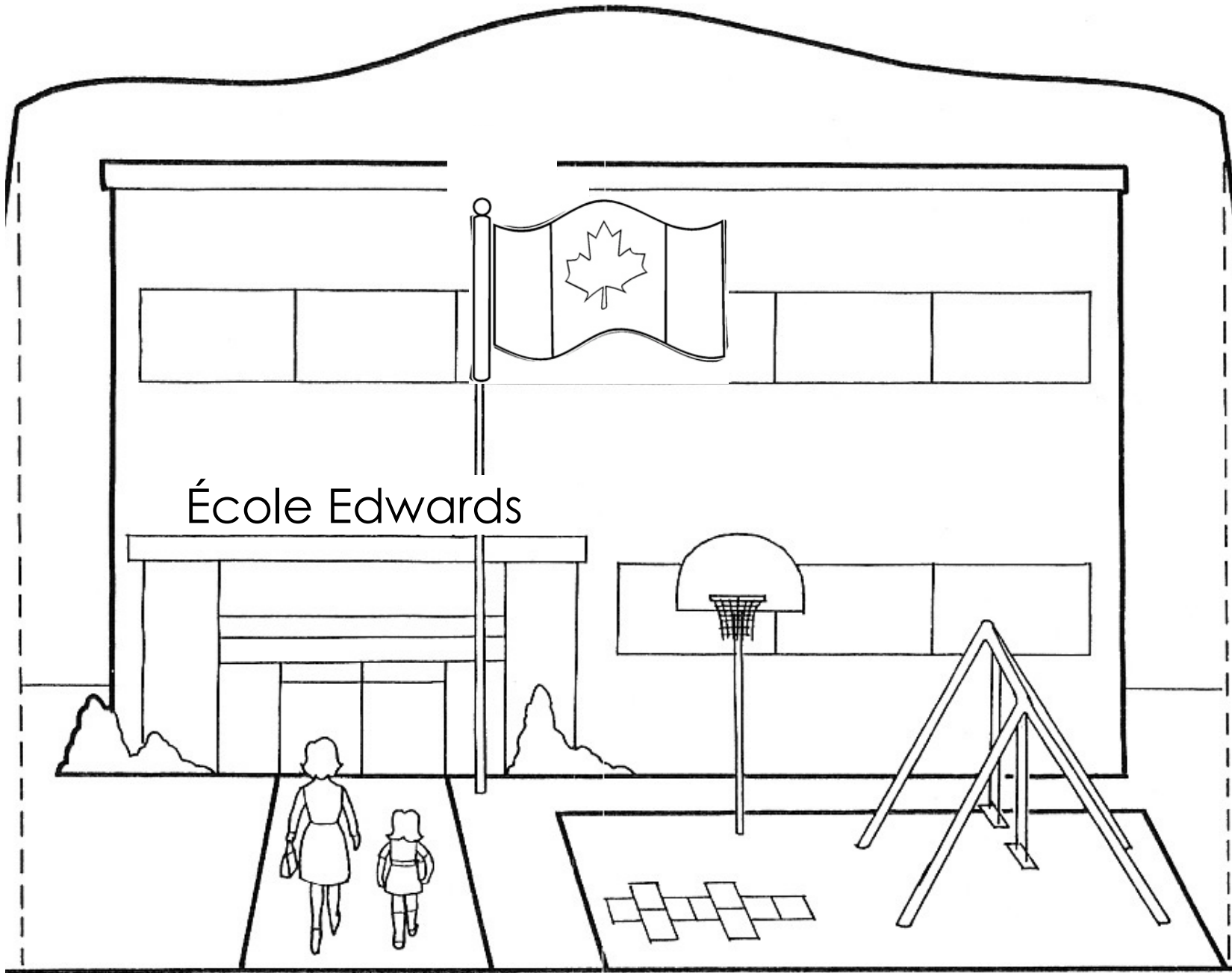

École Edwards

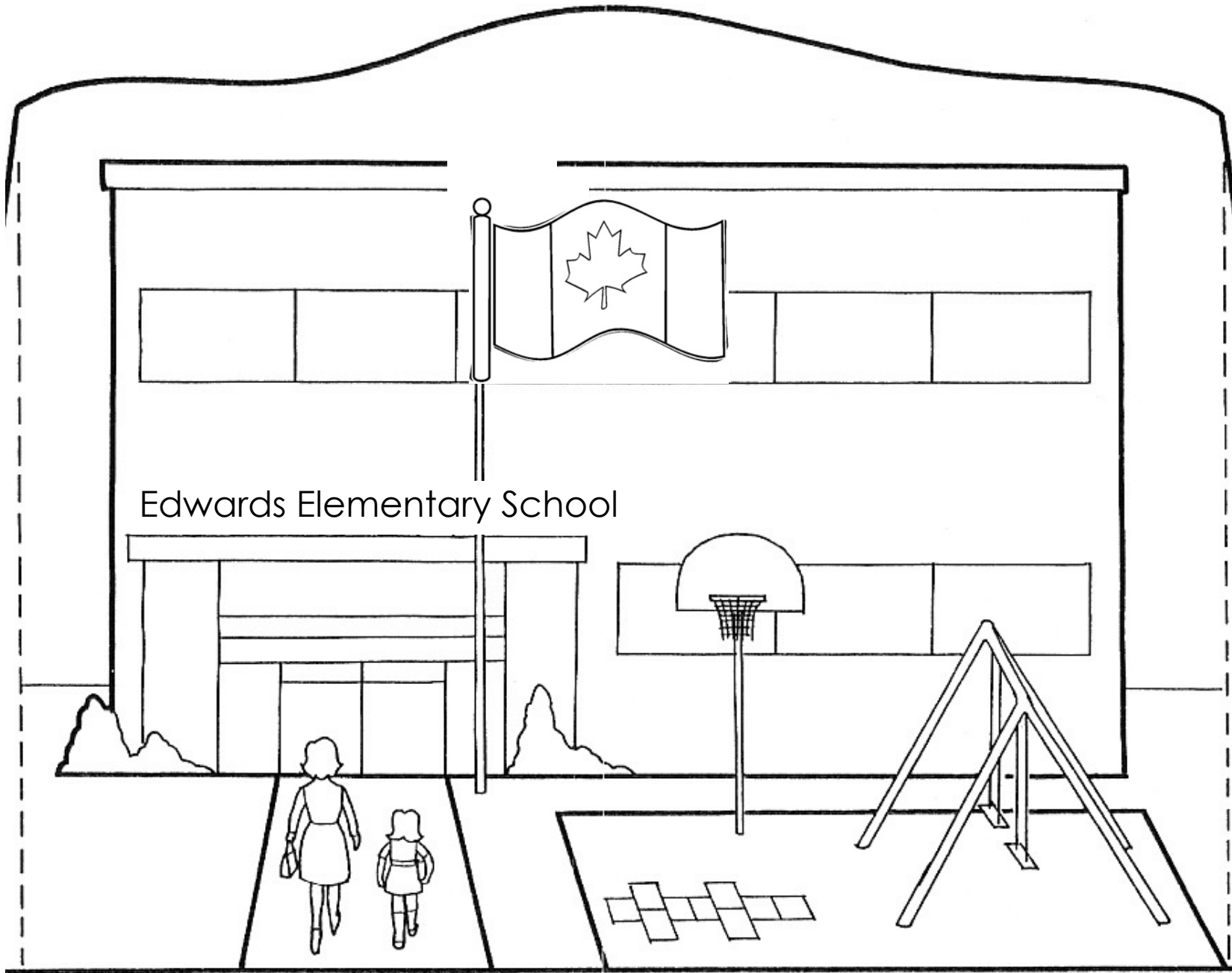

Edwards Elementary School

cater tot

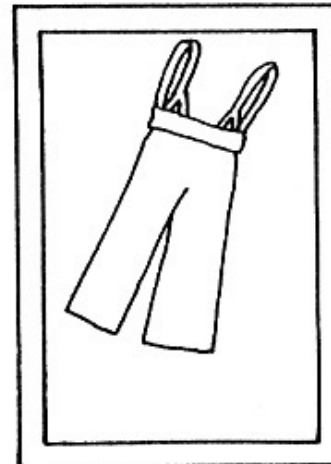
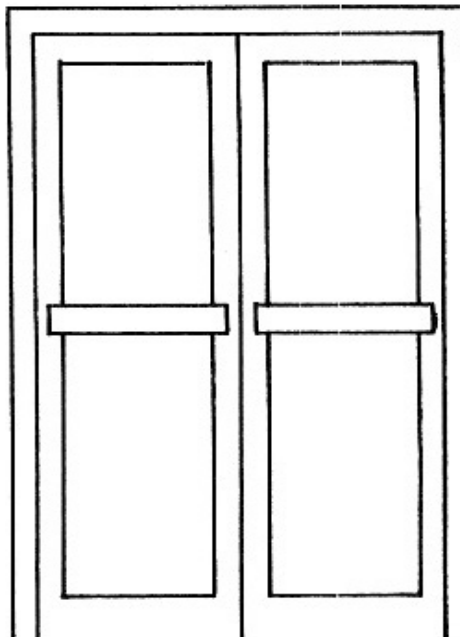
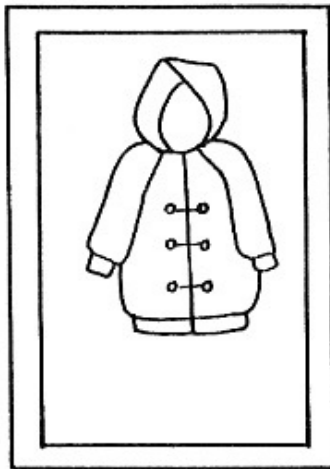

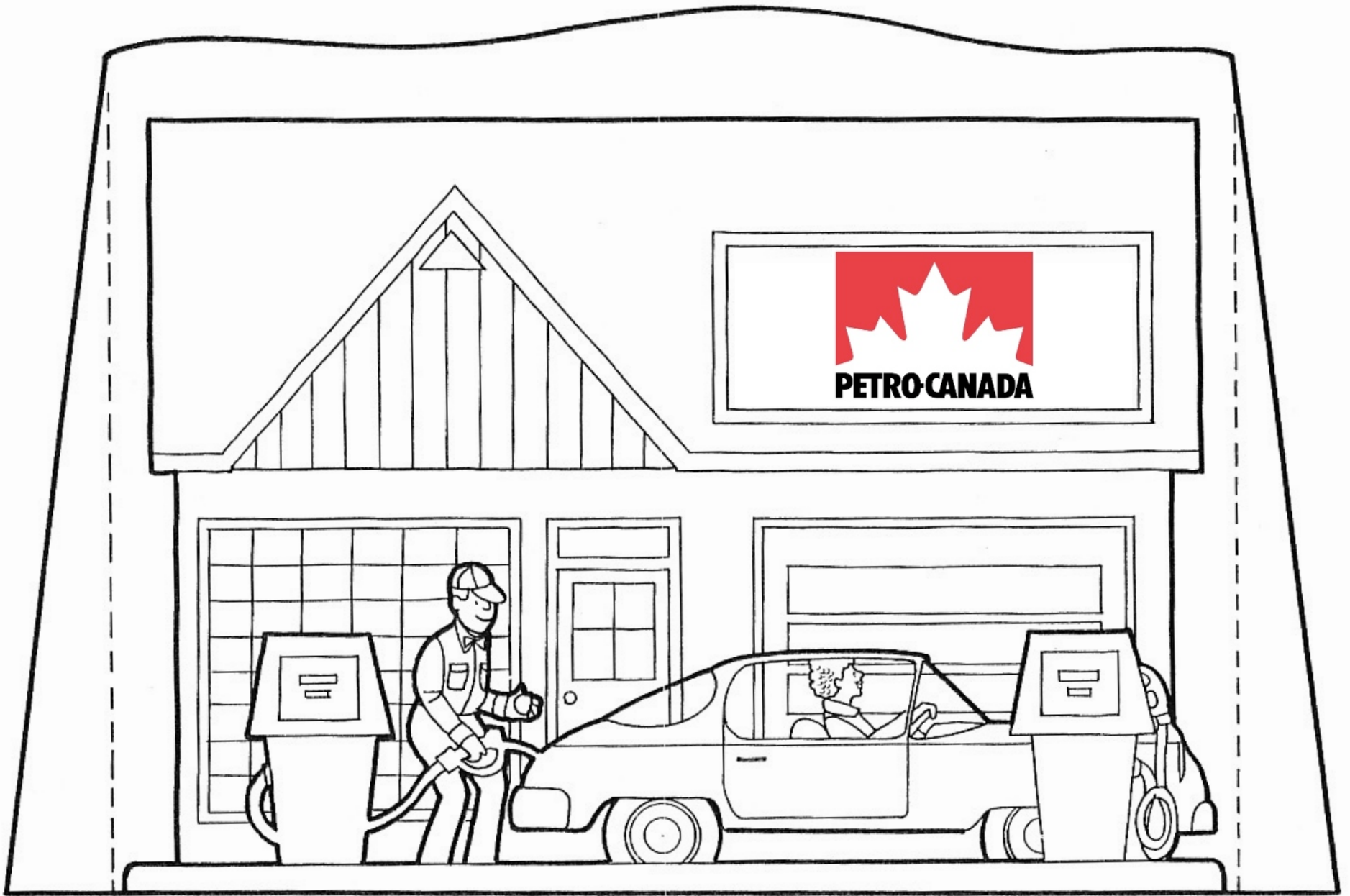

SUPERSTORE

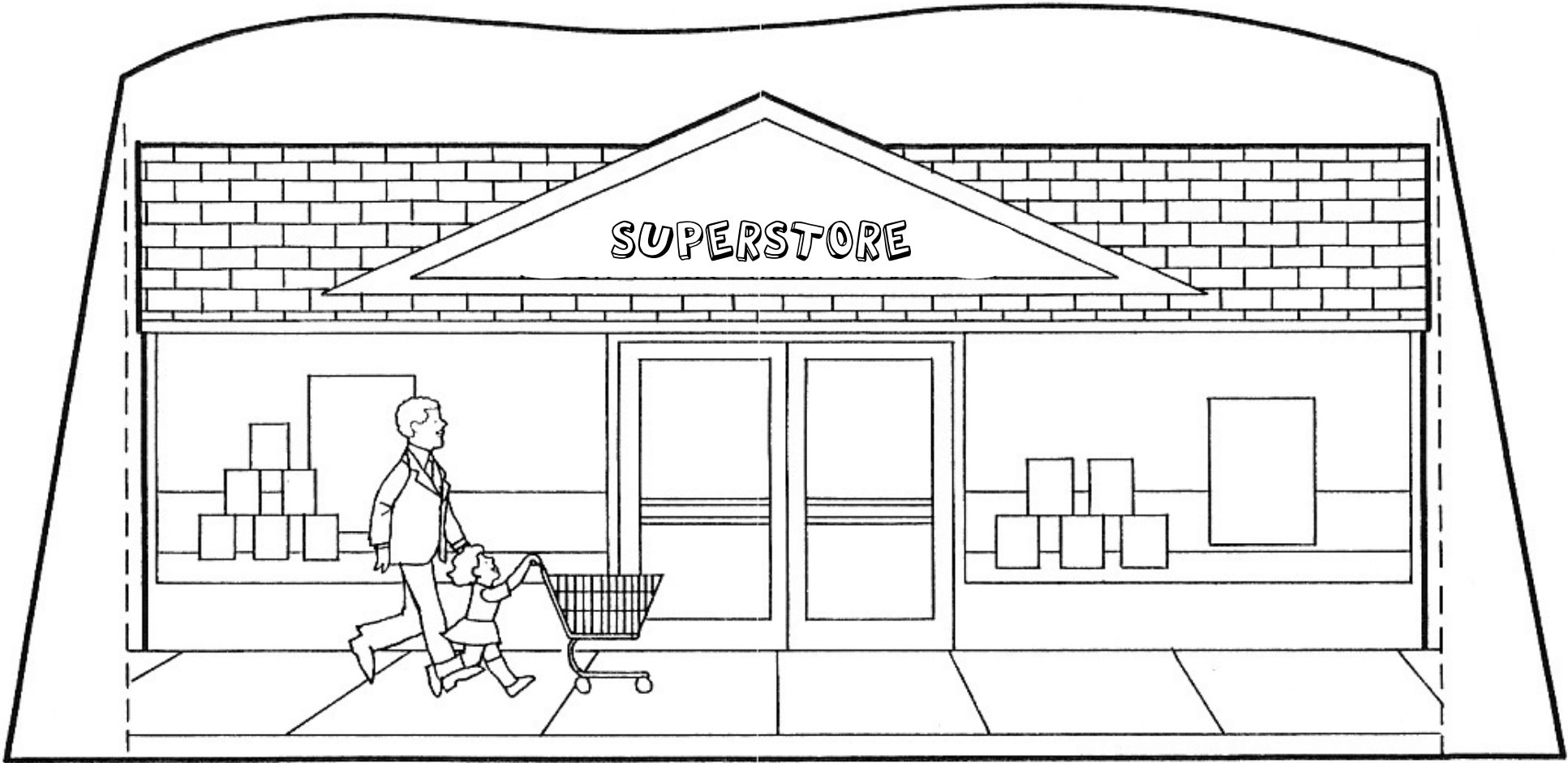



Airdrie Urgent Care Centre

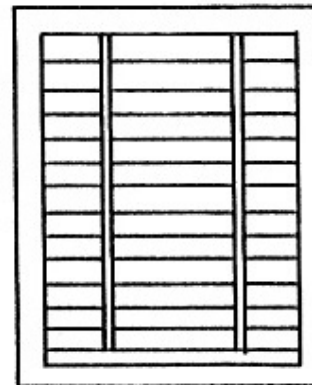
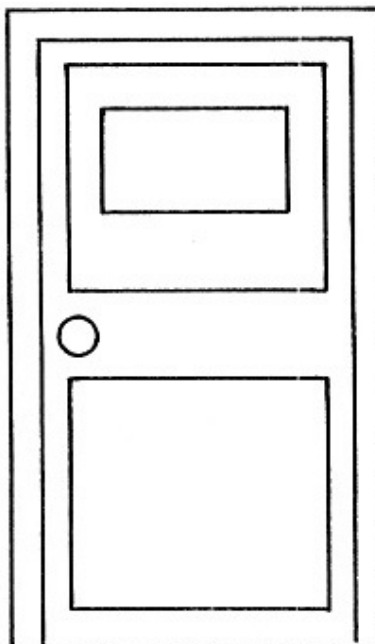
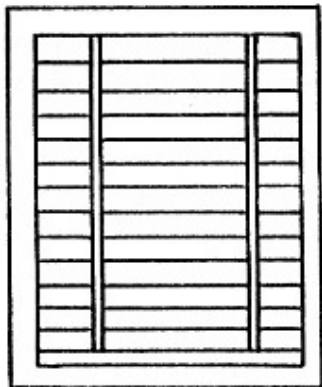

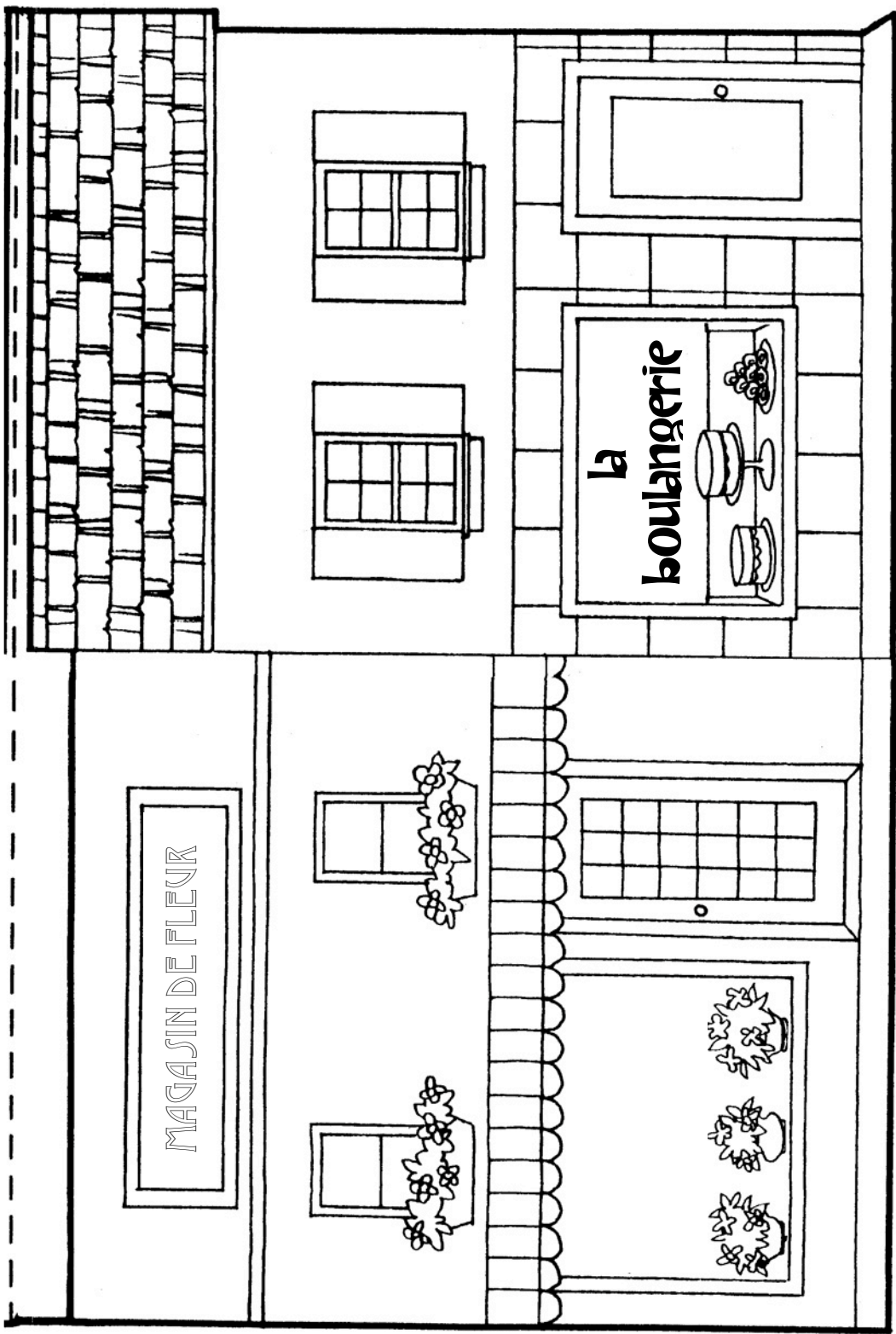

MAGASIN DE FLEUR

la  
boulangerie

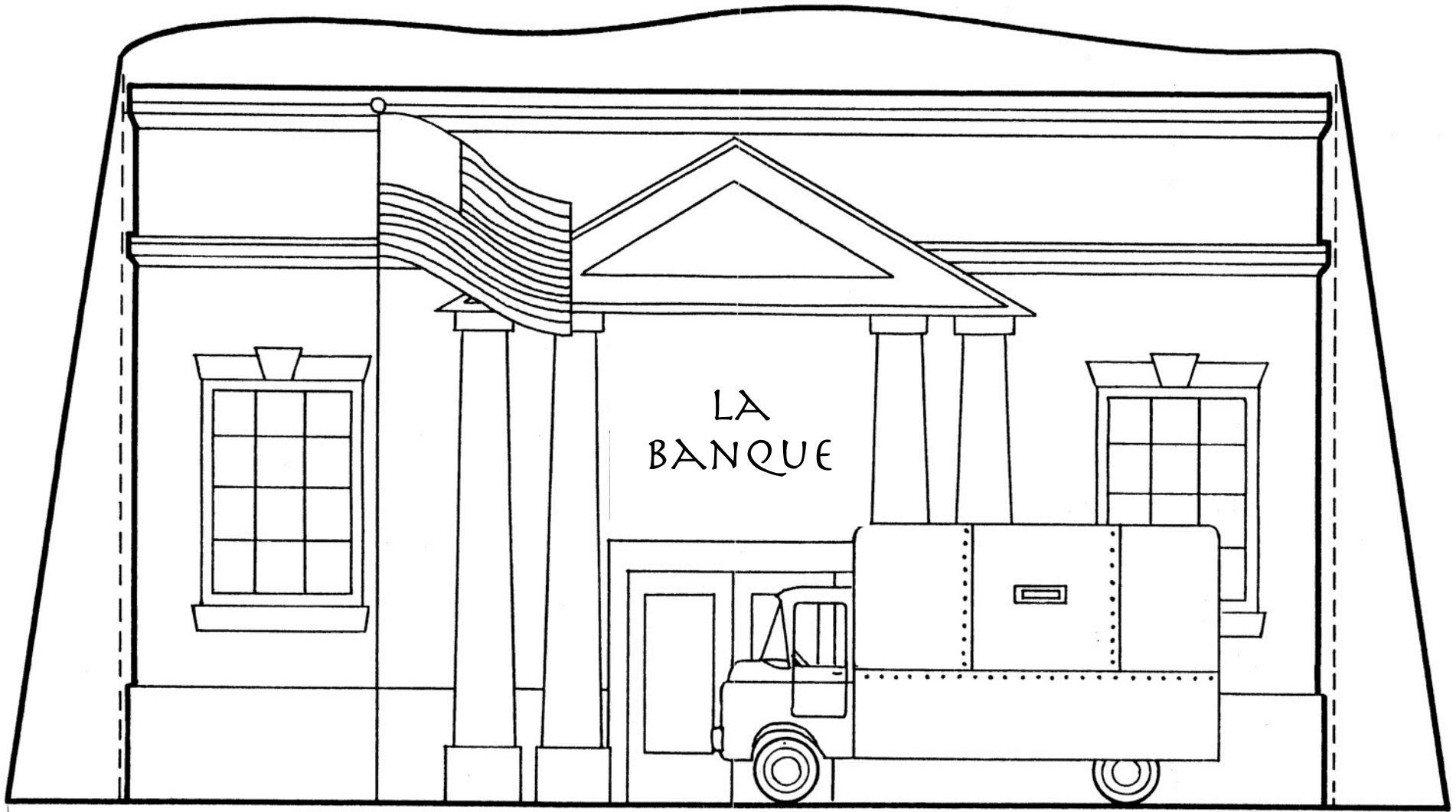

LA  
BANQUE



LA CASERNE DE POMPIERS

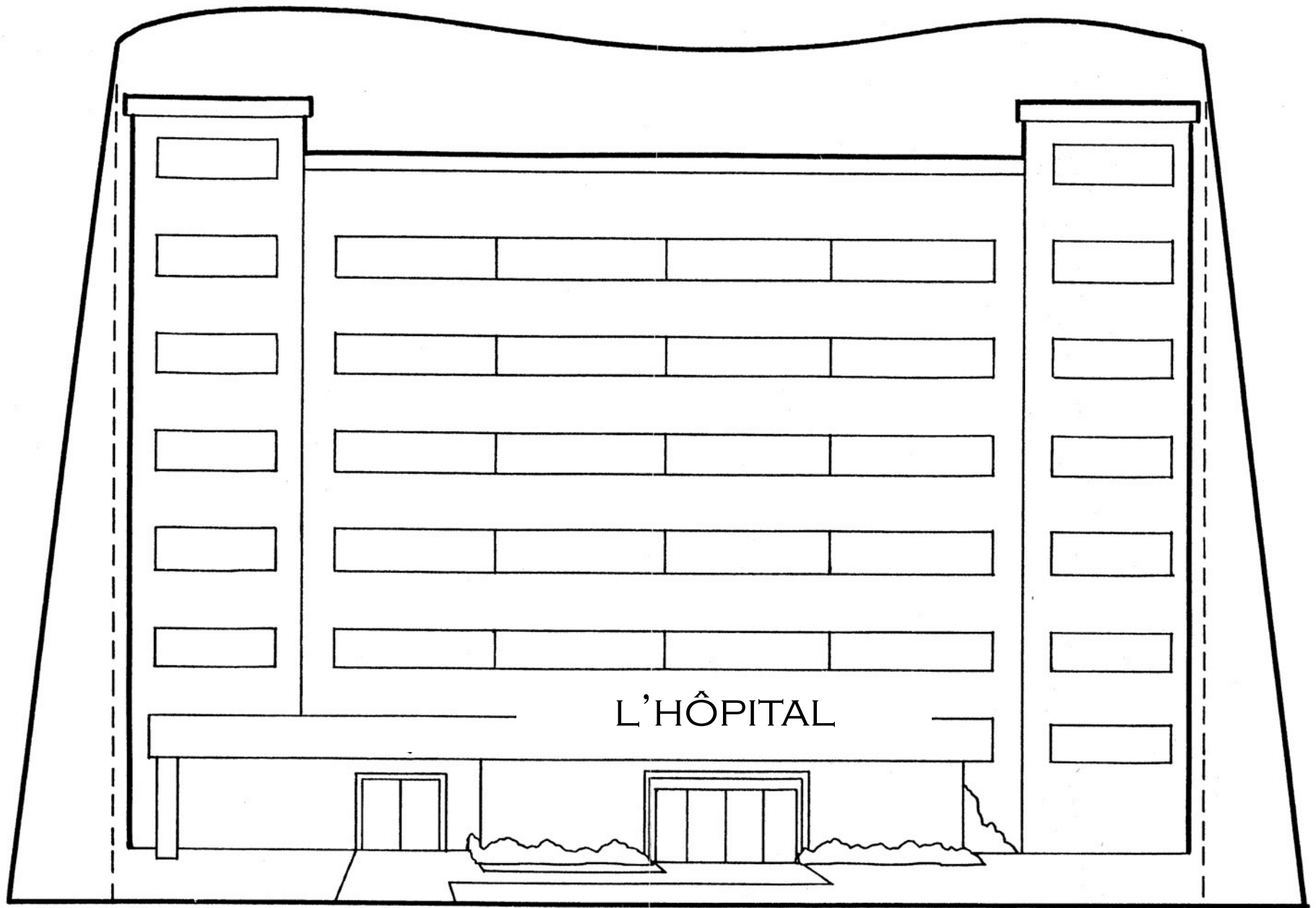

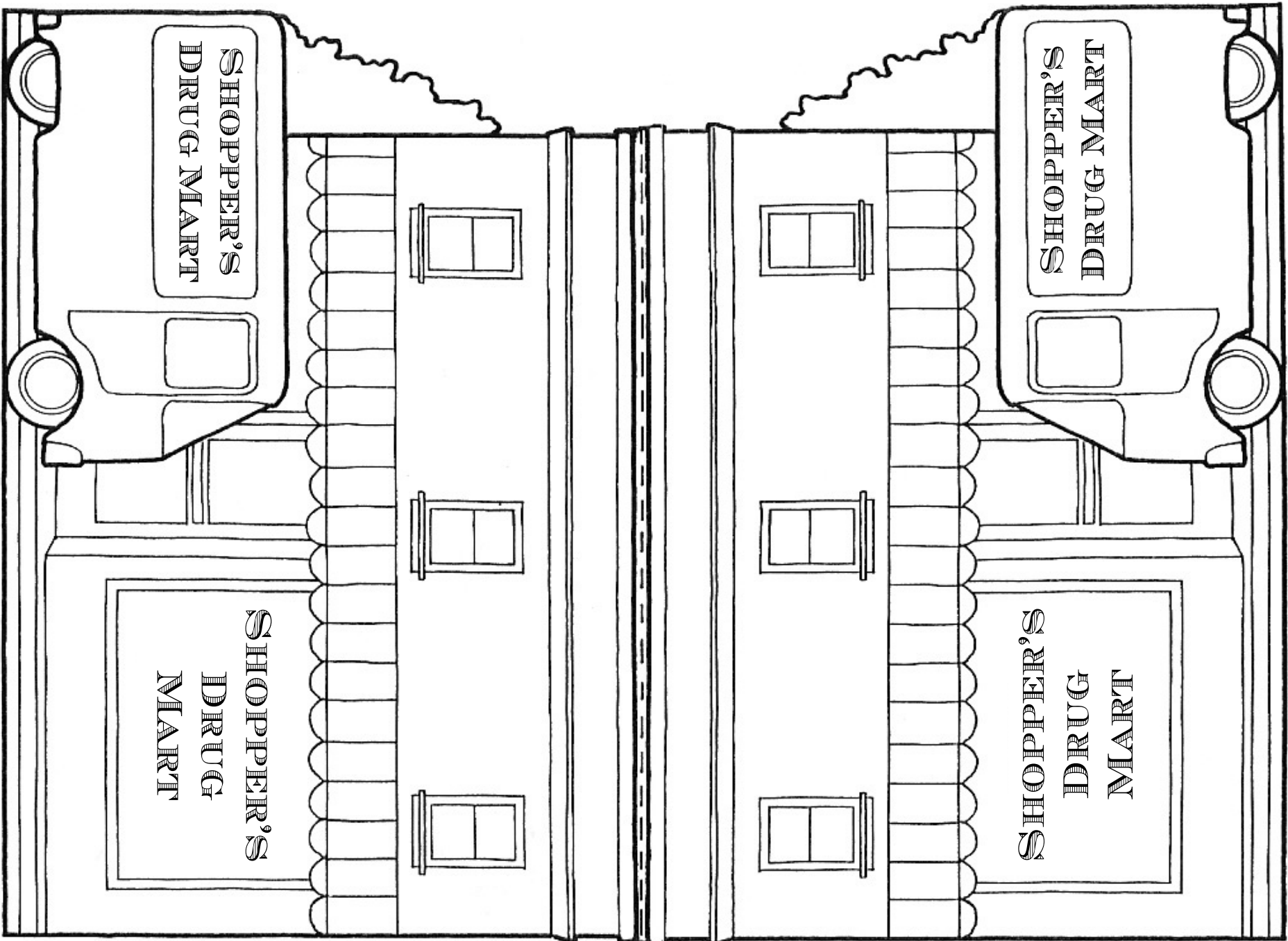

SHOPPER'S  
DRUG  
MART

SHOPPER'S  
DRUG MART

SHOPPER'S  
DRUG  
MART

SHOPPER'S  
DRUG MART







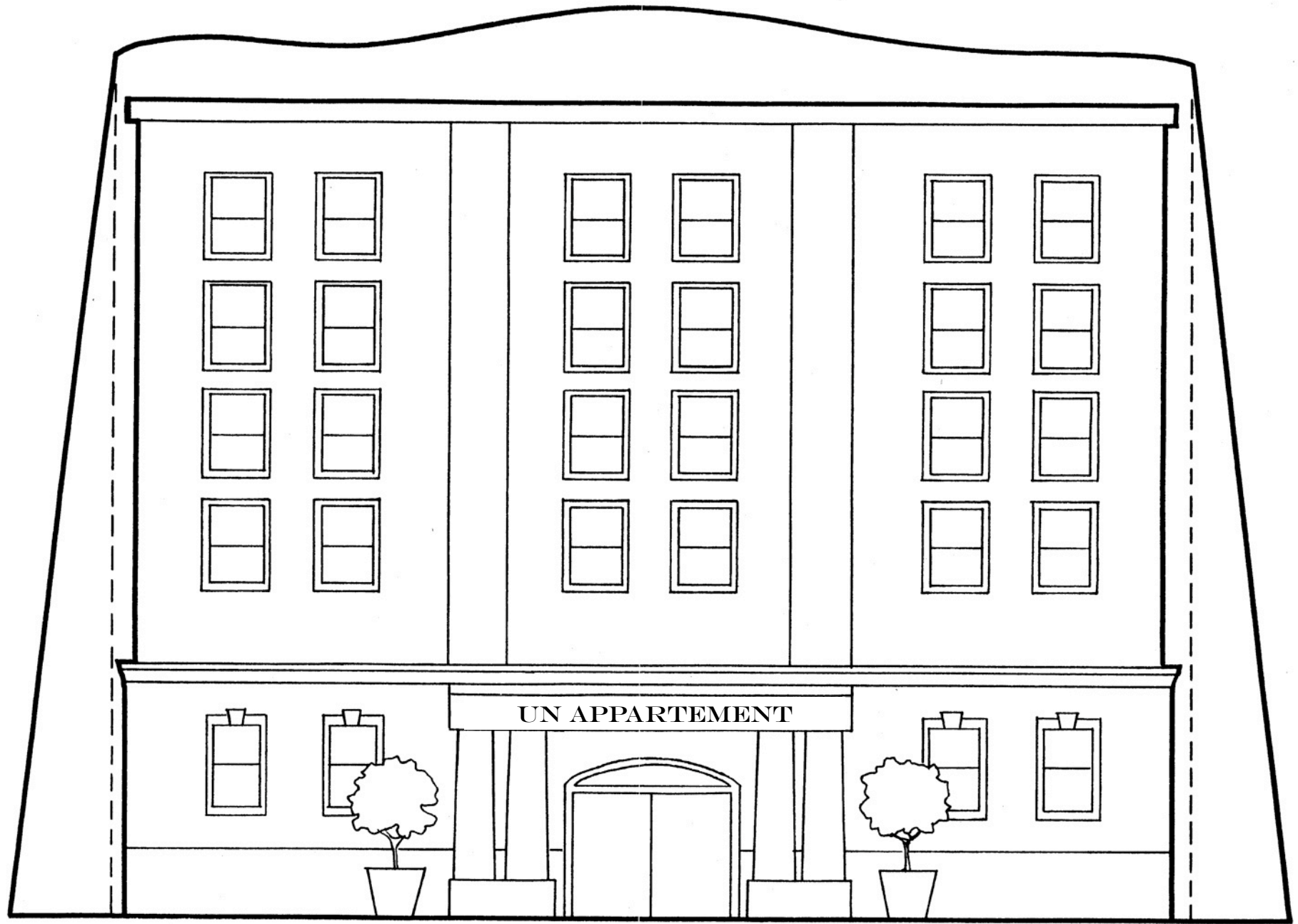

UN APPARTEMENT

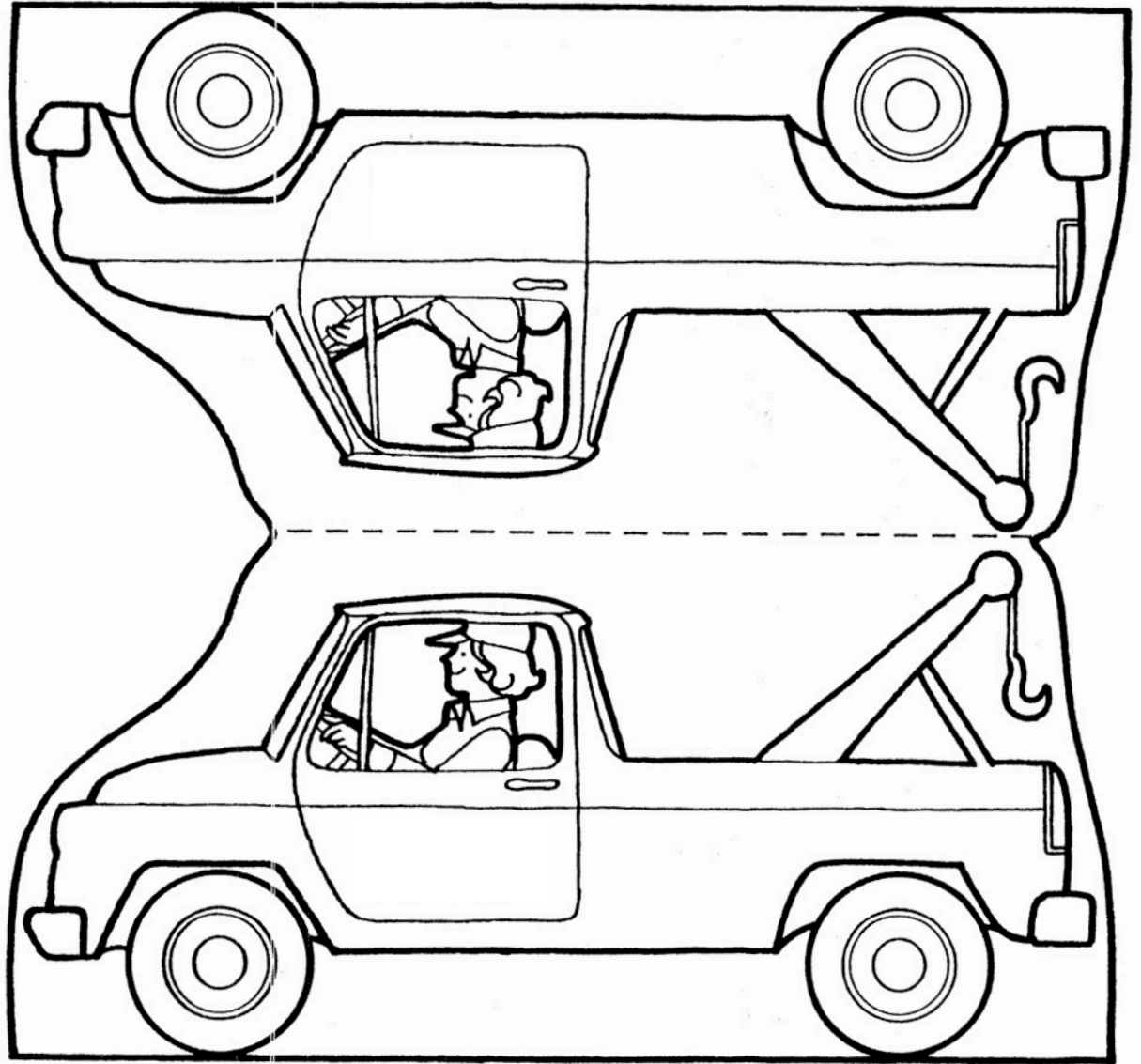
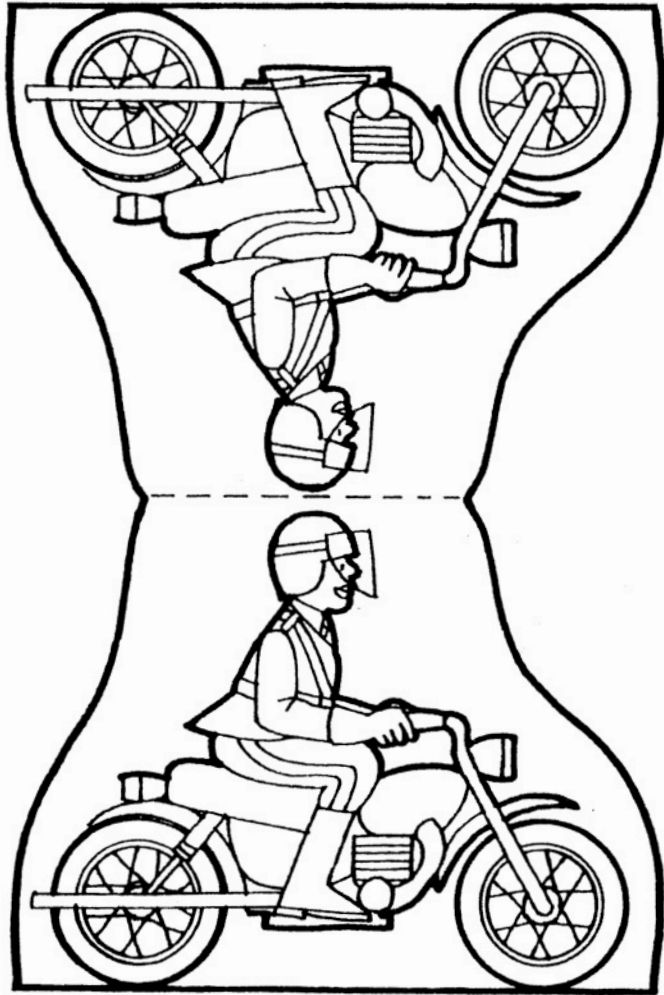

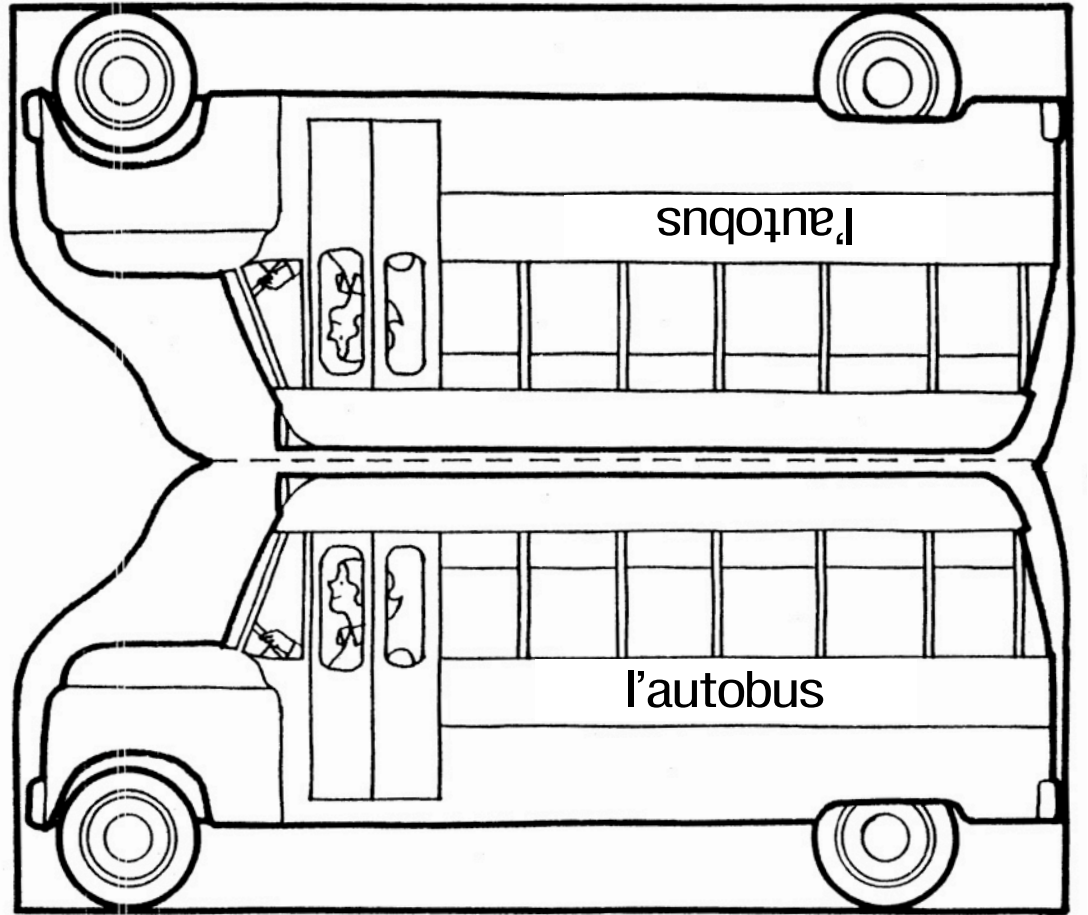
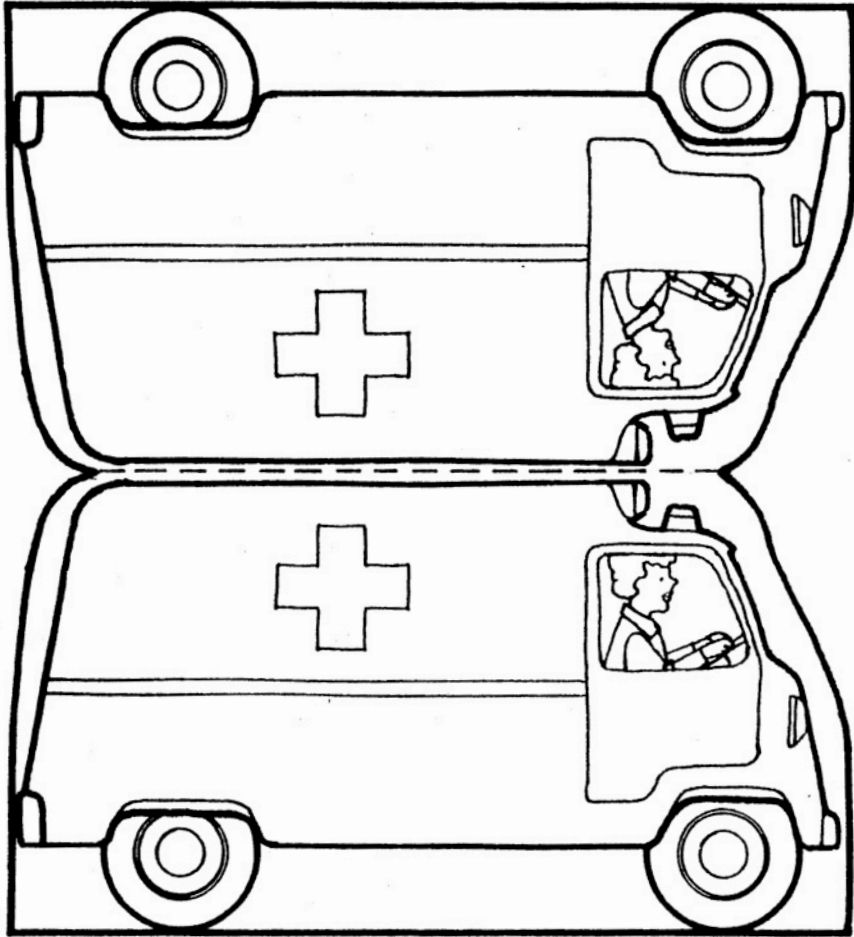

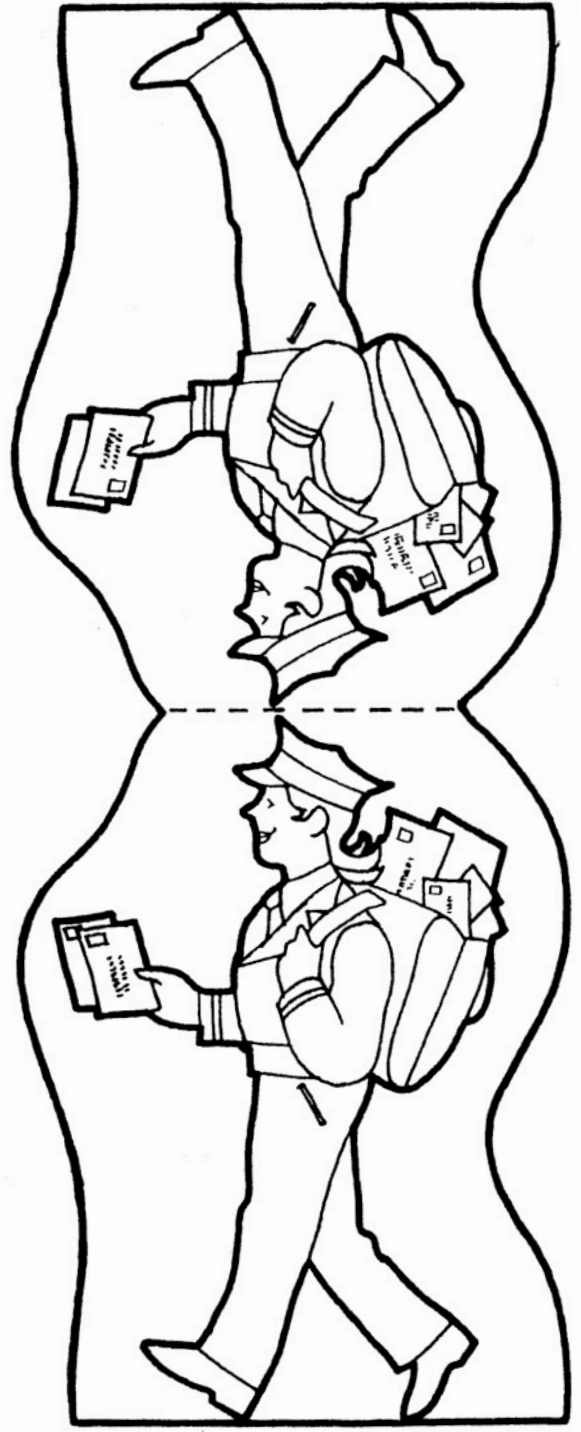
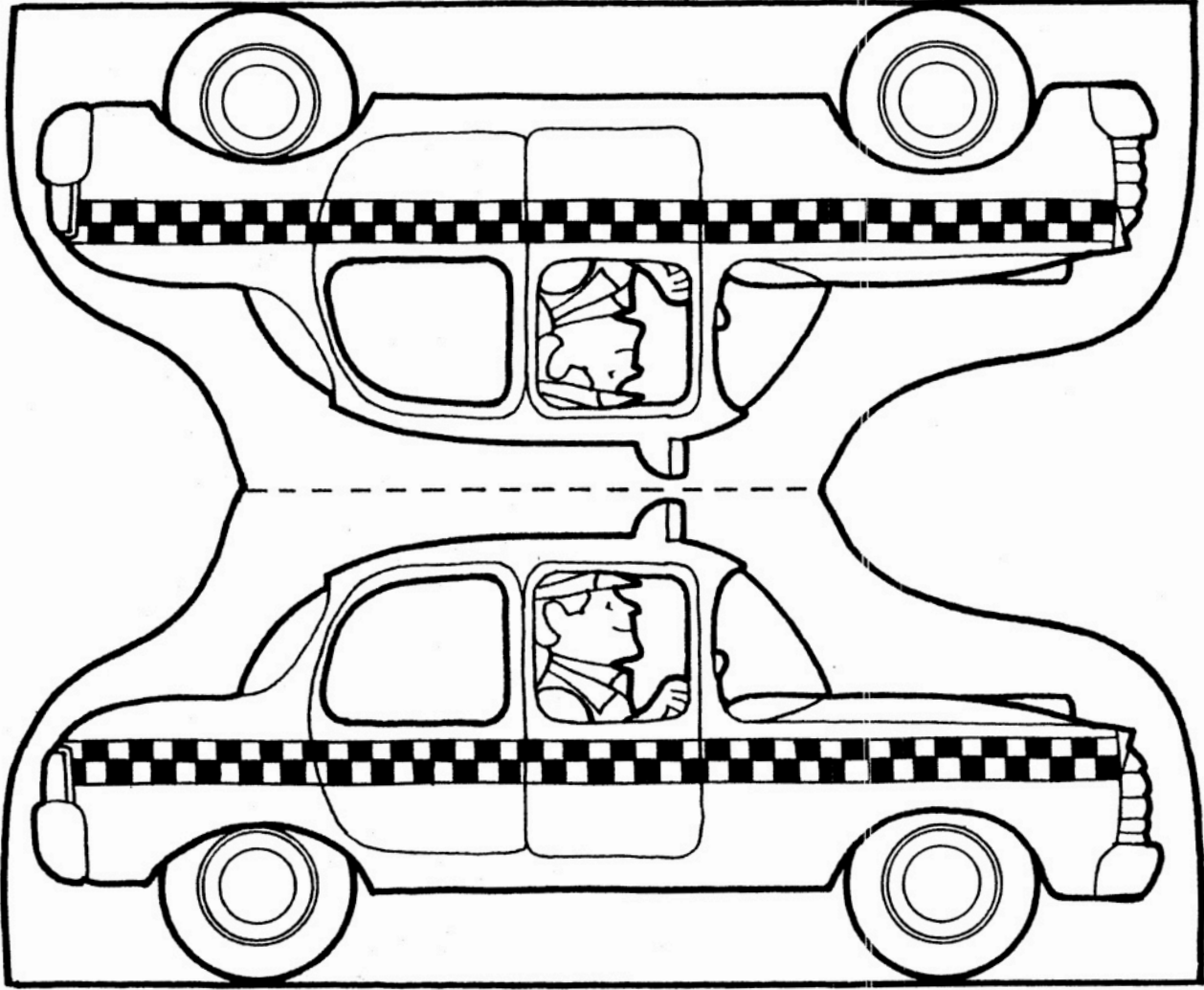

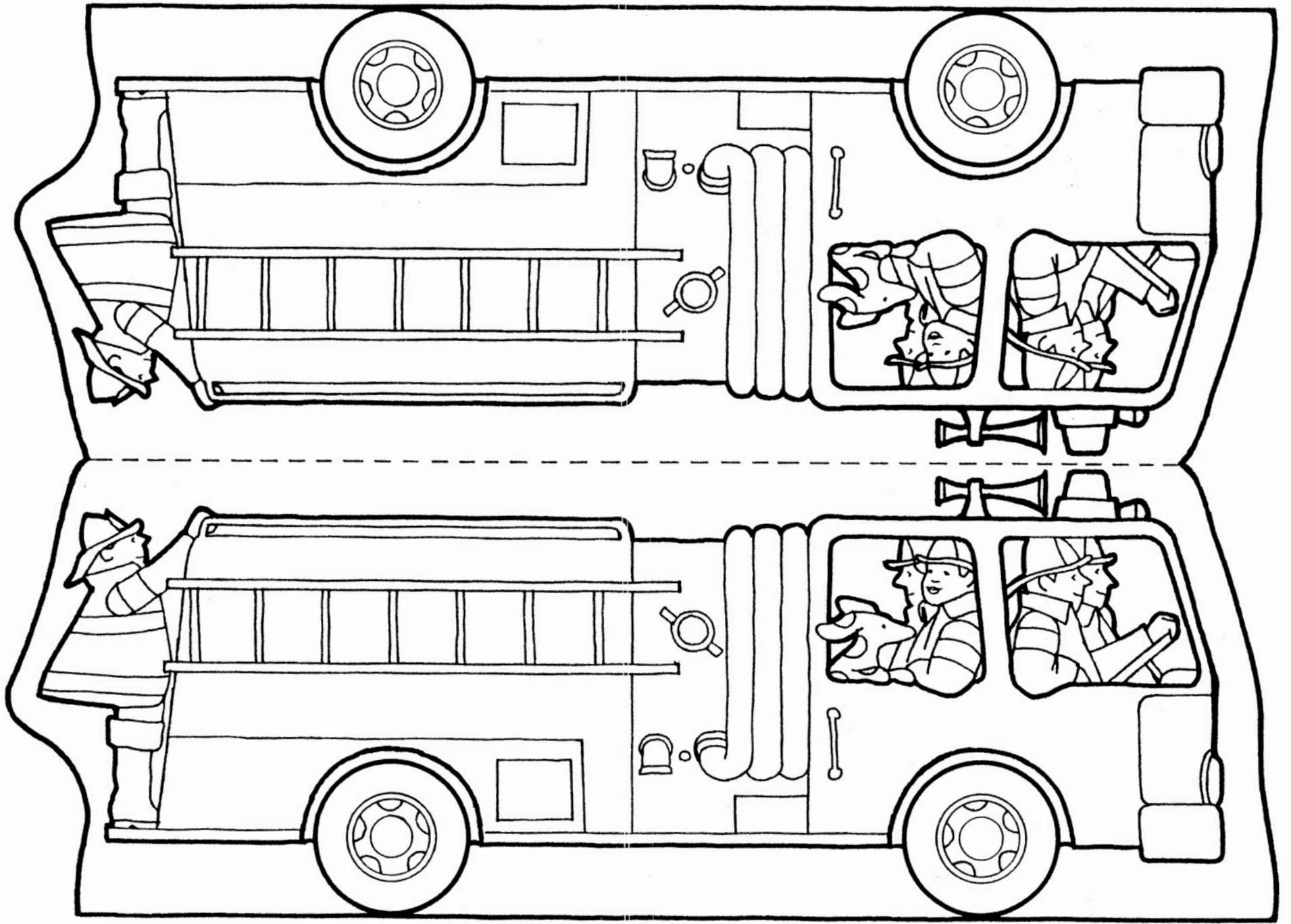

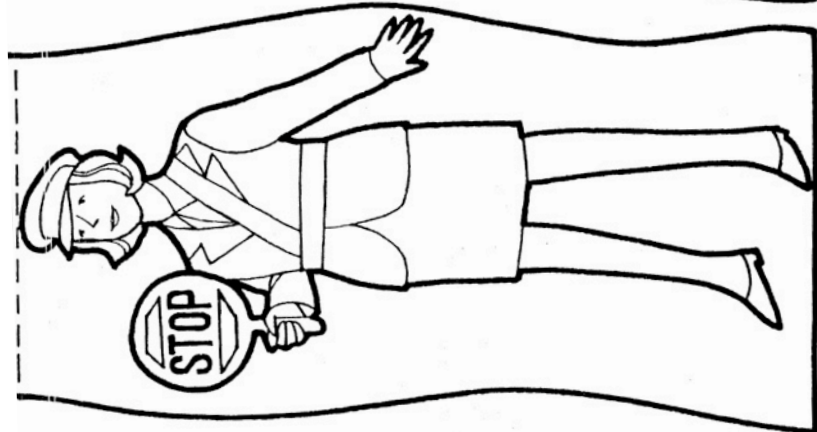
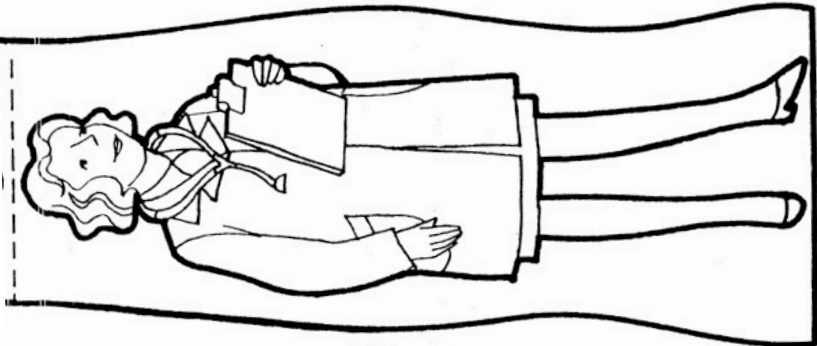
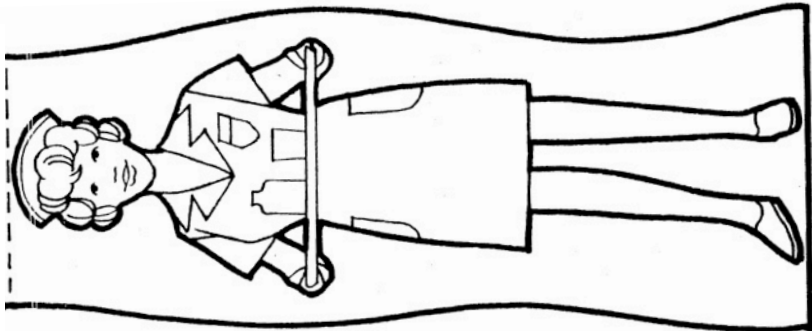
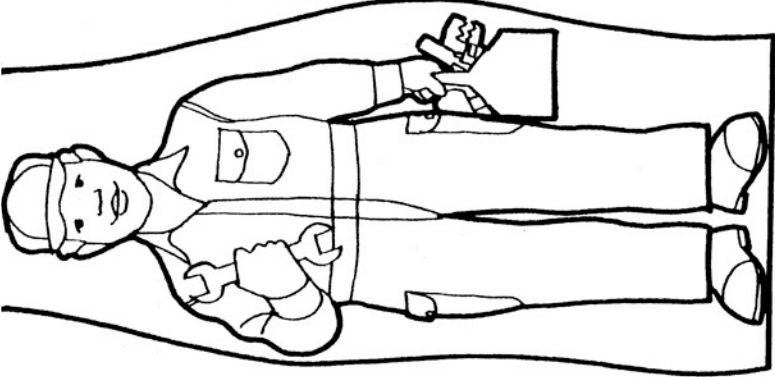
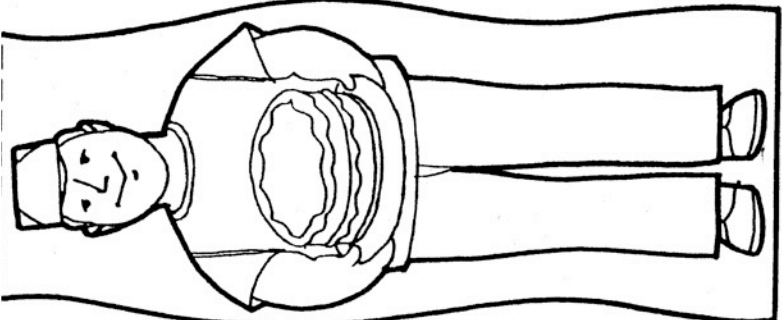
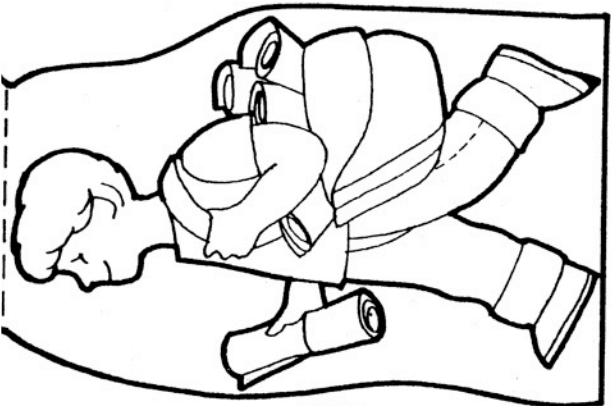



elle danse



elle court



elle saute



elle roule

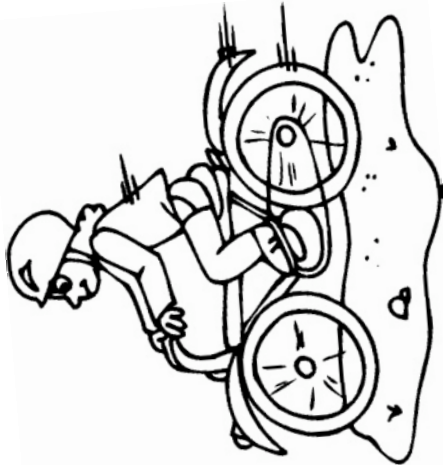

elle joue



elle botte



elle joue

il roule



il court



il nage

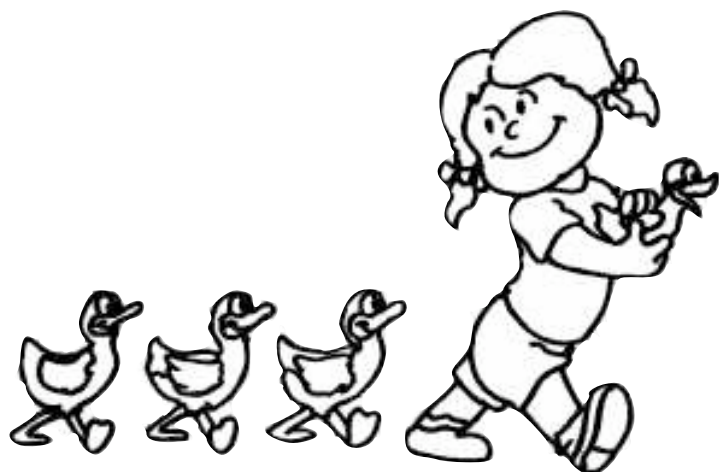

il botte



un cheval



une vache

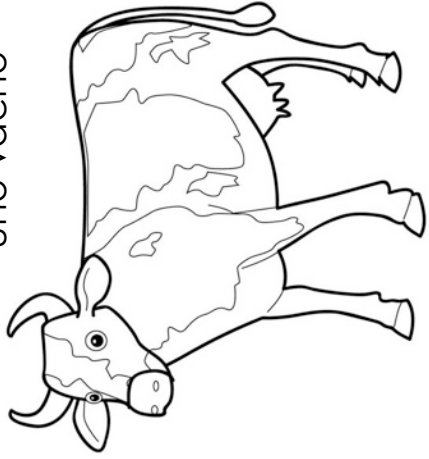

un cheval

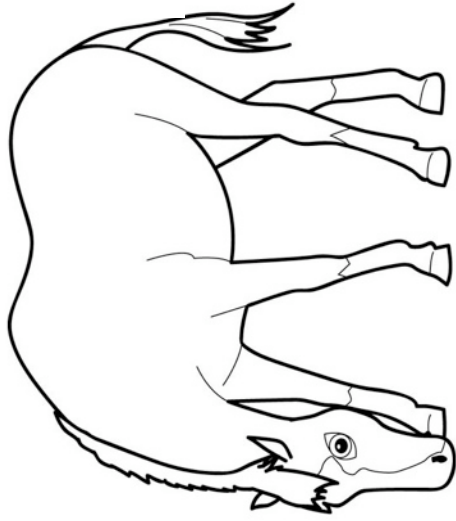

un cheval

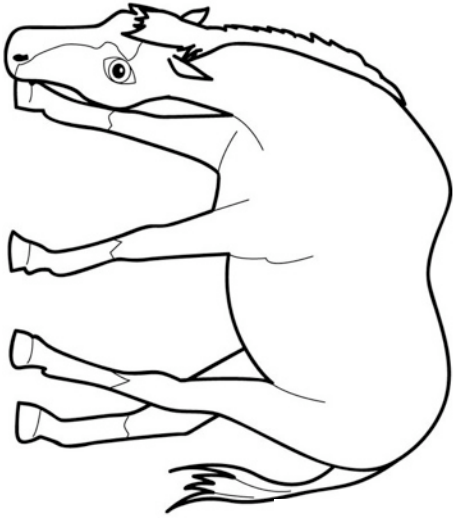

une vache



un cheval



un canard



un lapin

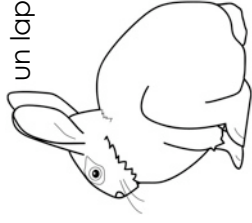

un lapin

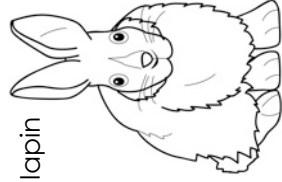

un chien

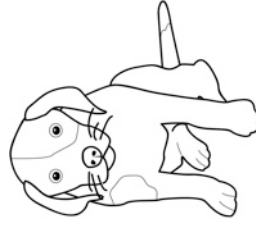

un chat



un chien



un serpent



un raton-laveur



un raton-laveur



un chien

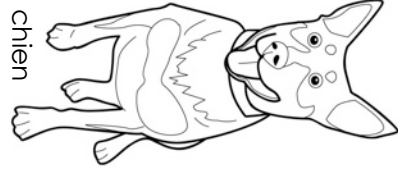

un chat



un serpent



un lapin



un lapin

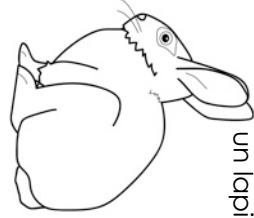

un canard

